

SolidSense II[®] (ATEX) Pressure Transmitters

Pressure Transmitters

Superior stability and reliability for demanding pressure measurement applications

Overview

The Brooks[®] SolidSense II[®] pressure transmitters are designed for stable, accurate, and reliable pressure monitoring in high purity and ultra-high purity (UHP) applications. A combination of optimum design and materials improves both signal stability and reliability in numerous pressure measurement applications.

Pressure transmitters are widely used in high purity and ultra-high purity fluid storage and delivery systems in many industries. Unfortunately, a number of current transducers rely on technologies that have problems with zero and span drift, thermal shift, and case stress. Adjusting the transmitter to rectify errors requires ongoing maintenance that increases downtime and cost of ownership.

The third generation SolidSense II pressure transmitters by Brooks Instrument utilize glass-fused strain gauge technology enabling a new level of performance for micro electronics and industrial applications.

SolidSense II pressure transmitters employ ultra stable, micro machined silicon strain gauges that are matched and fused to the metal diaphragm at high temperature to relieve manufacturing induced stress. The process reduces drift or lack of zero stability commonly associated with competitive products. Consequently, down time for zero adjustment to compensate for drift is significantly reduced. In addition, the unique mechanical design eliminates torque effects during installation.

SolidSense II digital architecture enables automated software driven calibration and a wide range of thermal compensation routines, unlike the passive compensation used in competitive devices. This enhances measurement repeatability regardless of changes to the operational environment.

SolidSense II devices feature 316L stainless steel wetted surfaces electropolished to 5- and 10-micro in. (5- and 10-Ra) to maintain the purity of the measured fluid.



SolidSense II[®] ATEX
Pressure Transmitter

Product Description

Industry Standard Interface

Options and outputs
(Bendix® connector shown as illustration. ATEX available with Pigtail connector only.)

Digital Thermal Compensation

Multi-point temperature compensation

Digital Linearization

Consistency of performance

Stress Isolation Stage

To reduce stress introduced during mounting

Fully Swept Flowpath

Complete removal of residual gas

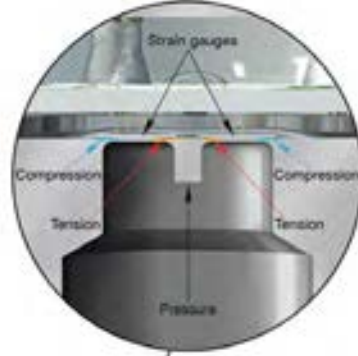

Sensor Attachment

Glass fusion bonding to relieve stress

Sensor Construction

Paired strain gauges to reduce stress induced drift

Wetted Materials

316L meets SEMI F20

Features	Benefits
Two pairs of strain gauge sensors	Precision matched sensors for improved performance
Glass fusion process to bond strain gauge	High temperature glass bonding drives off any mechanically induced build up of stress from sensor manufacturing process
Stress isolation stage	Minimizes stress introduced during installation of the transducer
Digital temperature compensation	Improved thermal stability over entire range of temperature
Digital linearization and calibration	Consistency of performance, improved reproducibility
Fully swept flowpath	Ensures contamination-free pressure measurement

Product Description

Sensor Construction

SolidSense II utilizes proprietary micro machined silicon strain gauges that are ultra stable and suitable for high purity and ultra-high purity requirements.

A design feature for controlling stress is the use of dual paired gauges. By using two paired gauges in Wheatstone bridge circuitry, pressure signal is maximized enhancing stability.

Sensor Attachment

A key step for eliminating machining stress in the diaphragm is the glass fusion process used to bond the strain gauges to the sensor diaphragm. This process occurs at 600°C and drives off any mechanically induced build up of stress resulting in a highly stable and accurate sensor.

By using silicon strain gauge technology and the glass fusion bonding method for SolidSense II, there is no stress induced from thermal gradients between structural materials. In some competitive designs, different thermal expansion coefficients between the metal casing and ceramic electrode (upon which the sensor is mounted) allow for flexing of the sensor which is interpreted as a false pressure change.

Stress Isolation Stage

SolidSense II incorporates an isolation stage shown at right that minimizes stress from: (1) thermal heating during any adjacent welding and (2) torque during installation in gas panels, gas interface boxes, valve manifold boxes, etc. By preventing stress during these two scenarios, creep (drift) is eliminated during subsequent usage.

Wetted Materials

Made from 316L that meets SEMI F20. Surface finish complies with SEMI F19. Product is assembled in clean environment compliant with ASTM F1374-92 - meets requirement for ultra-high purity application.

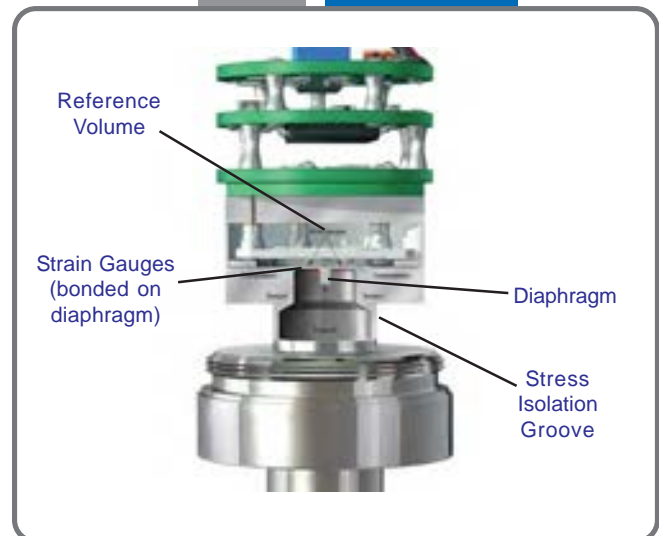
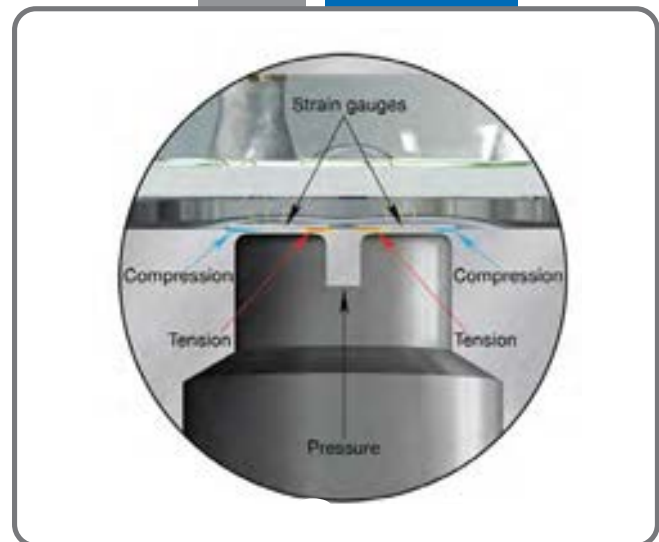
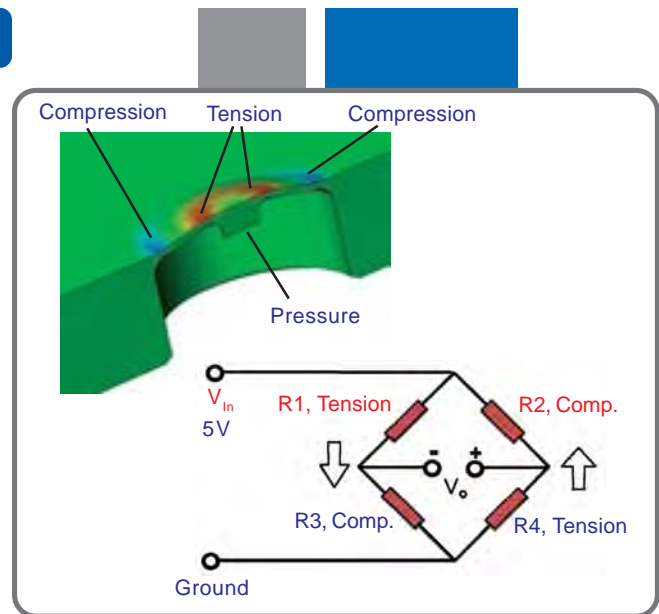

Product Description

Digital Linearization and Calibration

SolidSense II is calibrated with automated software which uses about 200 linearization points compared with 2 for some competing units. This results in consistency of performance from one transducer to the next (reproducibility). Due to automation, operator induced differences are eliminated.

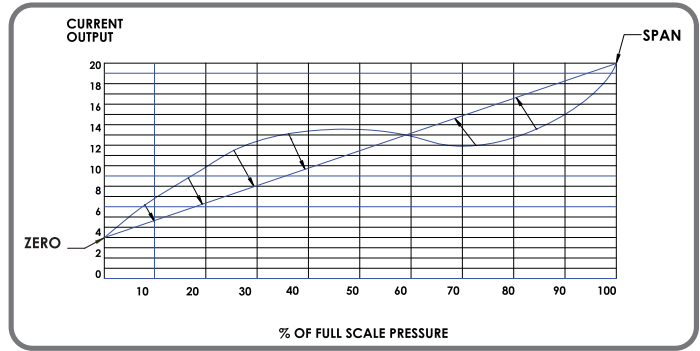

Digital Thermal Compensation

SolidSense II uses multi-point digital temperature compensation. Some competitive devices rely on single or two point compensation to optimize device performance over the operating temperature range. For example, device performance might be checked at -10°C and 60°C to determine the dZ/dT and dS/dT (rate of zero/span change per temperature change) with the temperature compensation interpolated for other values. SolidSense II can incorporate five separate data points, which are typically taken at -10°C, -5°C, 20°C, 40°C and 60°C, giving the temperature compensation algorithm far better resolution.

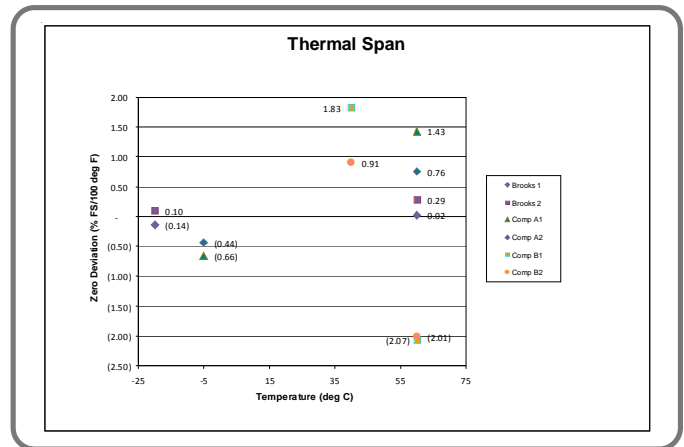
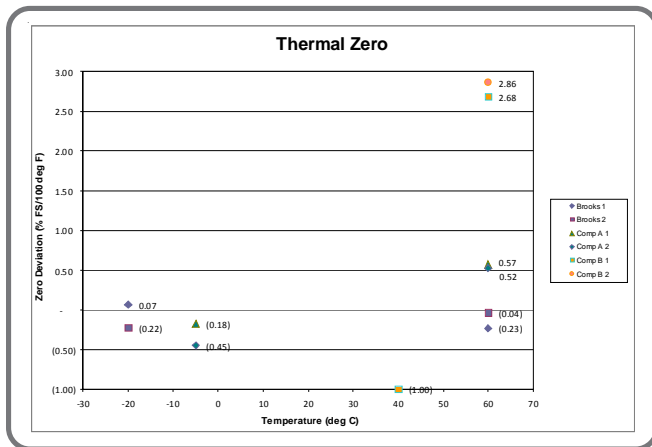

Fully swept flowpath

The SolidSense II incorporates an all-swept flowpath and very small internal volume allowing complete removal of residual fluid during the purge cycle. As a result inert, dry and clean surfaces are available at the end of the purge cycle.

ASTM F1397 establishes a dry-down requirement to 20 ppbv H2O within 30 minutes. As accompanying data shows, the dead end configuration of the SolidSense II recovered to desired level within 11.5 minutes and the flow thru configuration recovered in 9.5 minutes, both well below the requirement indicated in standard.

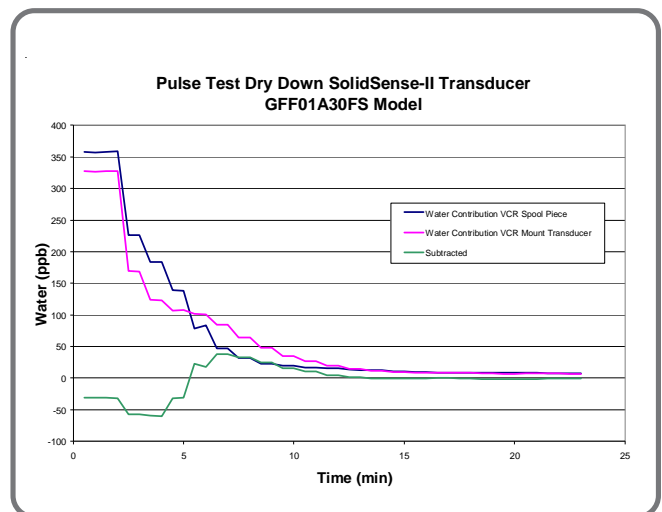
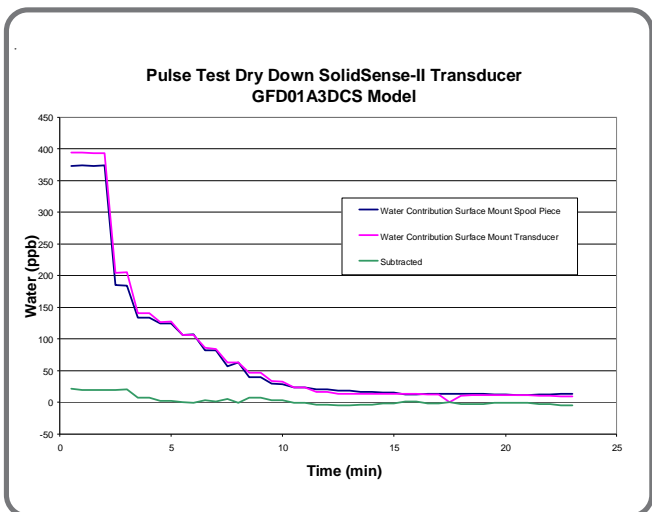

Product Description

Robustness

The SolidSense II design incorporates a stress isolation stage. This prevents stresses built up during installation of transducers from being transmitted to diaphragm. As a result, SolidSense II will not require frequent resetting of zero after installation and in operation.

A number of applications involve subjecting the pressure transducer to rapid pressure cycling in a purge cycle. As shown in test results, SolidSense II will not temporarily indicate inaccurate pressure readings due to the Joule-Thompson effect. In some competitive devices this may cause false alarms and shut down the gas distribution system.

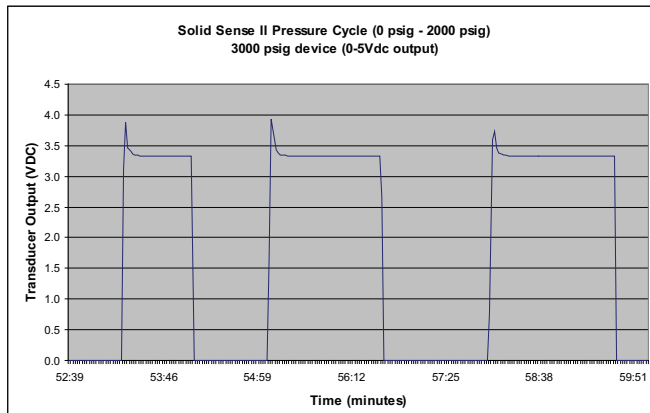

Accurate pressure readings during purge cycle

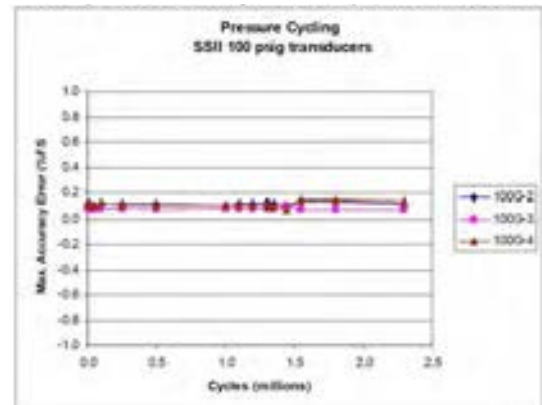

Stability - 2,000,000 pressure cycles without failure

Zero Stability

Minimal drift, creep and shifts during installation and service life.

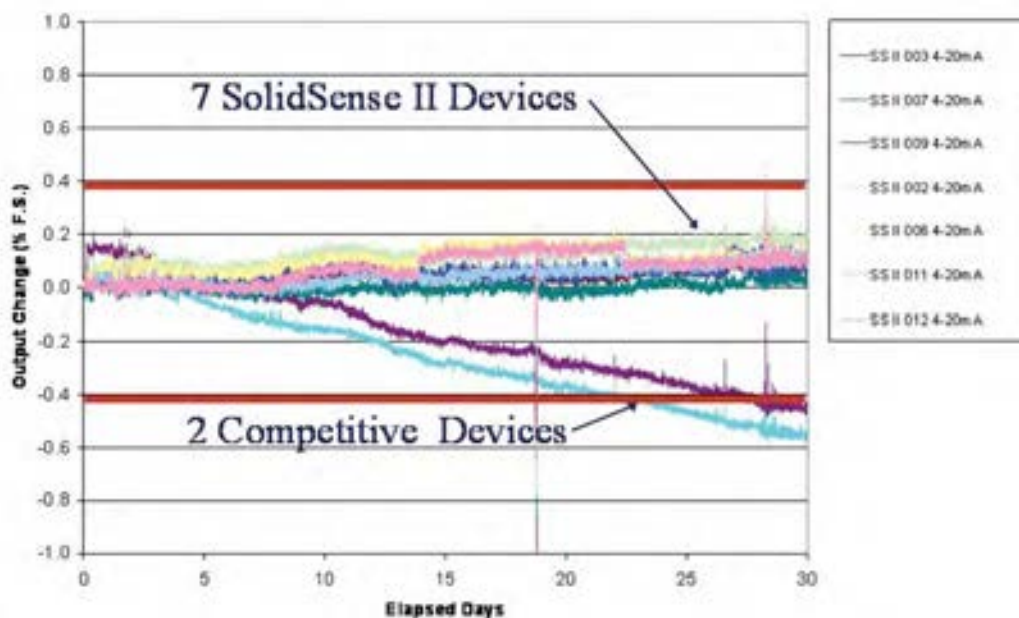

Metrology

Calibration system that is traceable to international primary standards with minimal uncertainty - precise dependable pressure measurements.

Product Applications

Sanitary Processes

Maintaining zero contamination of processed fluids is vital in a large number of industries such as food, dairy, beverage and pharmaceuticals. Instruments selected for use in these industries should deliver repeatable measurements without being a source of contamination. SolidSense II has a fully swept flow path with no hidden recesses or dead spaces. Sample wetted surfaces are electropolished 316L stainless steel with a 5 or 10 Ra surface finish.

Two typical applications are:

Measurement of liquid level in a tank

As shown in adjacent graphic, use of two SolidSense II pressure transmitters will enable the liquid level in tank to be measured hydrostatically.

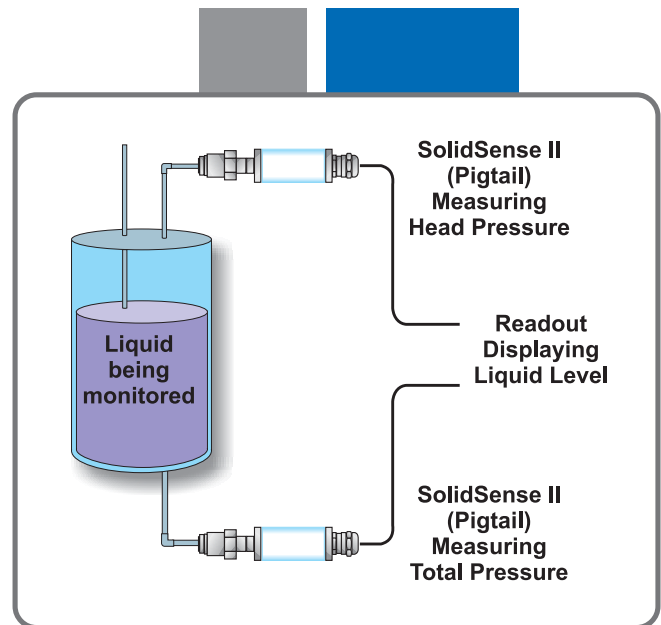

Measure build-up across filters

Many sanitary processes use filters to ensure product quality. As the load on the filter increases, a pressure differential between the inlet and outlet sides of the filter can be measured using SolidSense II. Once an established differential limit is reached, the filter can be preventively replaced before throughput goes down.

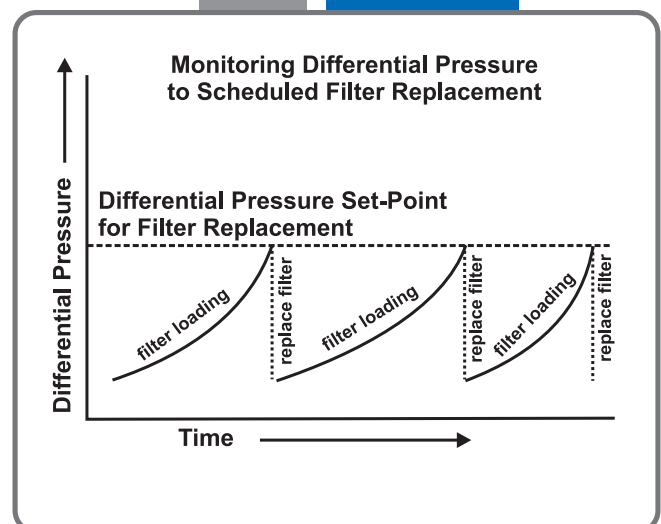
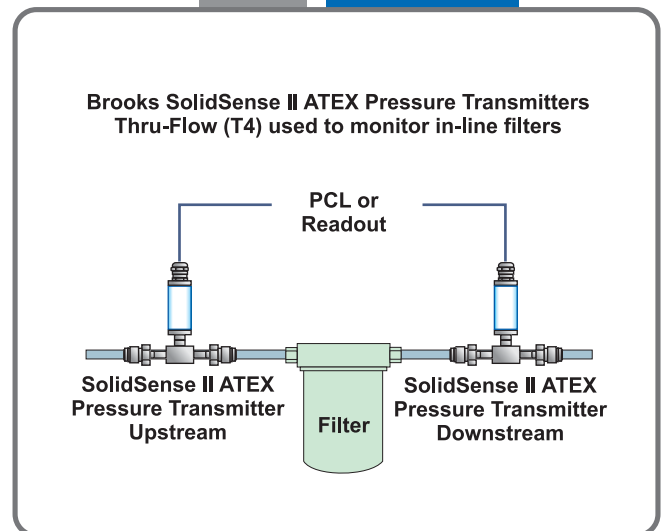

Product Applications

Monitoring Pump Discharge

It is imperative to measure pump discharge pressure for a positive displacement pump. In case the system encounters blockage, it can trigger important safety devices. This prevents pump from generating pressures in excess of the capability of piping system.

Installation of a SolidSense II pressure transmitter in the discharge line of the pump can give advance indication of this condition. This can prevent costly failure and cleanup. SolidSense II contributes to safe operation of such systems.

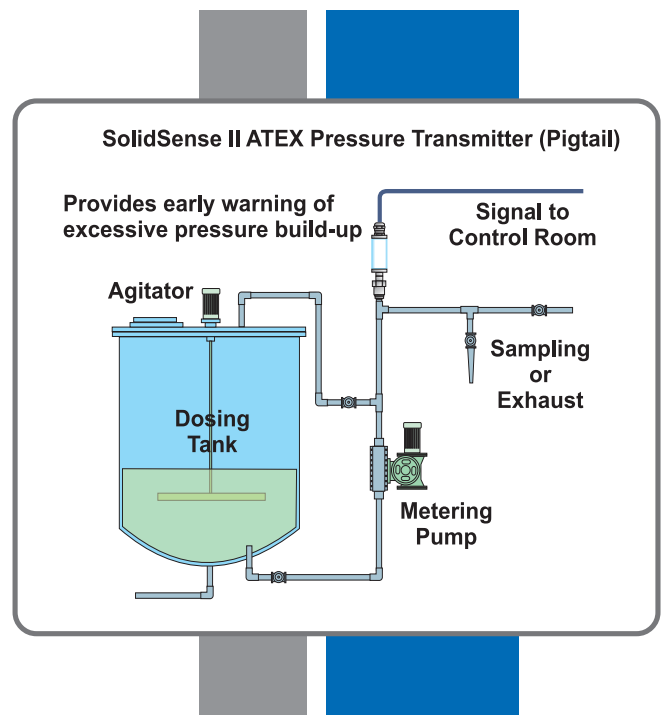

Product Dimensions (ATEX Compliant)

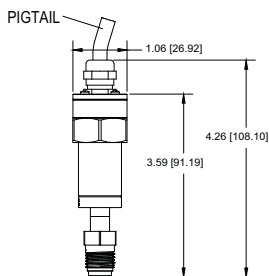

VCR SWIVEL MALE PIGTAIL
GFDXXXXPSMA
FITTING A333124001
ME131193

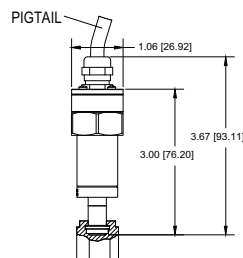

VCR SWIVEL FEMALE PIGTAIL
GFDXXXXPSFA
FITTING A333124002
ME131190

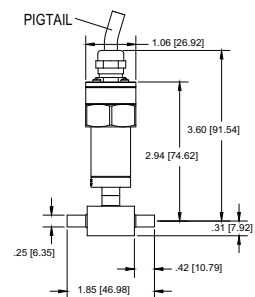

TUBE STUB/TUBE STUB
THRUTUBE PIGTAIL
GFFXXXXP4TA
FITTING A333125001

Product Specifications

Performance

Operating Temperature:	
Storage:	-20°F to 180°F (-29°C to 82°C)
Compensated:	-4°F to 140°F (-20°C to 60°C), 68°F to 140°F (20°C to 60°C) 0-10 Vdc version
Burst Pressure:	400% full scale
Proof Pressure:	200% full scale up to 1,000 psi, 150% full scale for higher ranges
Accuracy:	±0.25% full scale (BFSL)
Response Time:	< 5 msec
Zero and Span Temperature Coefficient (each):	
≥100 PSI Ranges Full Scale:	±0.02% full scale/°F (-40°F to 140°F, -20°C to 60°C) ±0.50% full scale (68°F to 140°F, 20°C to 60°C) 0 to 10 Vdc version
<100 PSI Ranges Full Scale:	±0.04% full scale/°F (-40°F to 140°F, -20°C to 60°C) ±1.00% full scale (68°F to 140°F, 20°C to 60°C) 0 to 10 Vdc version

Mechanical

Housing:	Stainless steel, polymer plastics
Wetted Parts:	316L stainless steel, SEMI F20
Surface Finish:	Compliant with SEMI F19
Cleanliness:	Compliant to ASTM F1374-92 (2005)
Internal Volume:	1.79cc
Process Connections:	(See Product Configurations for available options)
Approximate Shipping Weight:	0.70 lb. (0.32 kg)

Electrical

Supply Current:	Maximum 10 mA for 0.00 to 10.00 Vdc output and 0.05 to 5.05 Vdc output
Power Requirements:	10 to 30 Vdc for 4 to 20 mA output 11 to 30 Vdc for 0.05 to 5.05 Vdc output 13 to 32 Vdc for 0.00 to 10.00 Vdc output
Electrical Connections:	Pigtail (24 AWG shielded)
Electrical Protection:	Reverse polarity for power connections

SolidSense II (ATEX) Approvals and Compliance

ATEX (for ATEX compliant units only):	Equipment Group II, category 3 G. Compliant to EU Directive 94/9/EC
EMC:	Compliant to EU Directive 2004/108/EC
RoHS:	Compliant to EU Directive 2002/95/EC
FM Approval:	Non-Incendive for use in Class I, Div II Groups A, B, C and D Hazardous Applications Excludes 0 to 10 Vdc and 15-pin HD D-Sub connector configurations
NEMA	Enclosure complies to NEMA 4X

Model Code

Code	Description	Code Option	Option Description
I.	Base Model Code	GF	Pressure Transducer
II.	Body Type	D	Dead End
		F	Flow Through
III.	PSI	00	30
		01	100
		02	250
		05	500
		10	1000
		25	2500
		30	3000
IV.	Pressure Reference	A	Absolute, psi
		C	Compound, psi
		G	Gauge, psi
		E	Absolute, mPa/kPa
		R	Compound, mPa/kPa
		D	Gauge, mPa/kPa
		B	Absolute, Bar
		P	Compound, Bar
V.	Output	4	4 to 20 mA
		5	0.05 to 5.05 Vdc
VI.	Electrical Connection	P	6' (2m) Pigtail
		M	5" (0.127m) Pigtail
VII.	Fittings	4S	Tube Weld Stub 1/4" O.D. (GFD Only)*
		CS	Surface Mount, 1.125" C-Seal, Standard (GFD Only)
		CH	Surface Mount, 1.5" C-Seal, High Flow K1H (GFD Only)
		SC	Surface Mount, 1.5" C-Seal (GFD Only)
		5W	Surface Mount, 1.5" W-Seal (GFD Only)
		4W	Surface Mount, 1.125" W-Seal (GFD Only)
		NT	1/4" NPT (GFD only)
		VM	Face Seal, fixed male (x2 on Duncan T for GFF) (GFF only)
		VS	Face Seal, fixed male/swivel female on Duncan T (GFF Only)
		SM	Face Seal, swivel male (x2 on Duncan T for GFF)
		SF	Face Seal, swivel female (x2 on Duncan T for GFF)
		4T	Duncan T, 1/4" Tube Weld Stub (GFF Only)*
		3T	Duncan T, 3/8" Tube Weld Stub (GFF Only)*
		3M	Duncan T, 3/8" with Face Seal, swivel male (GFF Only)
		2T	Duncan T, 1/2" Tube Weld Stub (GFF Only)*
CT	Tube Stub, 3/8" OD (Suitable for compression joint) (x2 on Union T for GFF)(GFD & GFF)		
VIII.	Explosion Proof	A	ATEX approved

* Tube stubs (4S, 4T, 3T and 2T) are not suitable for compression joint. Use CT for compression joint.

Sample Model Code

I	II	III	IV	V	VI	VII	VIII
GF	F	02	C	4	P	SF	A

Brooks Service and Support

Brooks is committed to assuring all of our customers receive the ideal flow solution for their application, along with outstanding service and support to back it up. We operate first class repair facilities located around the world to provide rapid response and support. Each location utilizes primary standard calibration equipment to ensure accuracy and reliability for repairs and recalibration and is certified by our local Weights and Measures Authorities and traceable to the relevant International Standards.

Visit www.BrooksInstrument.com to locate the service location nearest to you.

START-UP SERVICE AND IN-SITU CALIBRATION

Brooks Instrument can provide start-up service prior to operation when required. For some process applications, where ISO-9001 Quality Certification is important, it is mandatory to verify and/or (re)calibrate the products periodically. In many cases this service can be provided under in-situ conditions, and the results will be traceable to the relevant international quality standards.



CUSTOMER SEMINARS AND TRAINING

Brooks Instrument can provide customer seminars and dedicated training to engineers, end users, and maintenance persons.

Please contact your nearest sales representative for more details.

HELP DESK

In case you need technical assistance:

Americas	 1 888 554 FLOW
Europe	 +31 (0) 318 549 290
Asia	 +81 (0) 3 5633 7100

Due to Brooks Instrument's commitment to continuous improvement of our products, all specifications are subject to change without notice.

TRADEMARKS

Bendix Amphenol Areospace
Brooks Brooks Instrument, LLC
SolidSense II Brooks Instrument, LLC



DS-PR-SolidSense II ATEX-PT-eng (0112)

Brooks Instrument
407 West Vine Street
P.O. Box 903
Hatfield, PA 19440-0903 USA
T (215) 362 3700
F (215) 362 3745
E-Mail BrooksAm@BrooksInstrument.com
www.BrooksInstrument.com

Brooks Instrument
Neonstraat 3
6718 WX Ede, Netherlands
T +31 (0) 318 549 300
F +31 (0) 318 549 309
E-Mail BrooksEu@BrooksInstrument.com

Brooks Instrument
1-4-4 Kitasuna Koto-Ku
Tokyo, 136-0073 Japan
T +81 (0) 3 5633 7100
F +81 (0) 3 5633 7101
E-Mail BrooksAs@BrooksInstrument.com